

PESO POR MARCO: 8.70 t

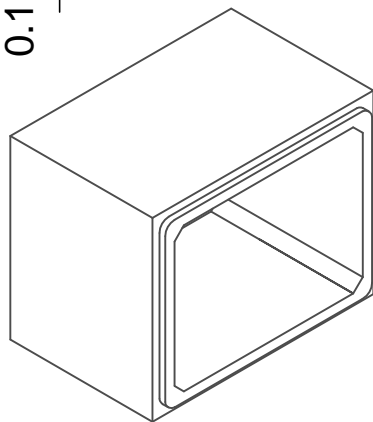

MARCO 2.25x2.00x2.00 (18/18)



PREFABRICADOS FORTE, S.L.
22.270 Ctra. Artasona s/n, Almudévar (Huesca)

NORMA: EN 14844:2007 + A2:2012 - Febrero 2012



REV:

A

REALIZADO POR:

P.G.P.

FECHA:

29/04/2020

VERIFICADO POR:

P.G.P.

REEMPLAZA A:
