

PESO POR MARCO: 8.43 t

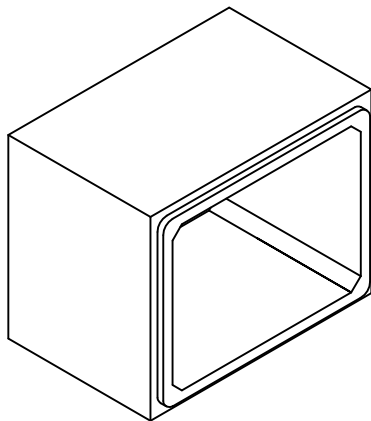

NORMA: EN 14844:2007 + A2:2012 - Febrero 2012



MARCO 2.50x1.20x2.00 (20/20)



PREFABRICADOS FORTE, S.L.
22.270 Ctra. Artasona s/n, Almudévar (Huesca)

REV: A	REALIZADO POR:	P.G.P.	FECHA:	13/01/2019
	VERIFICADO POR:	P.G.P.	REEMPLAZA A:	----