

PESO POR MARCO: 12.83 t

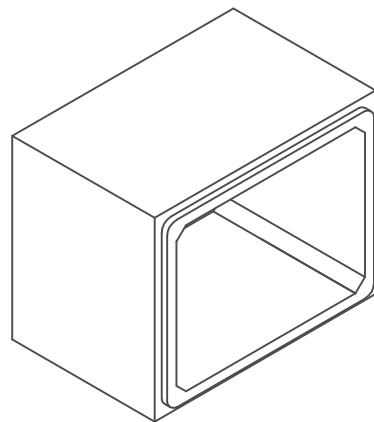

**NORMA:** EN 14844:2007 + A2 - Febrero 2012



## MARCO 2.50x3.50x1.50 (20/30)



PREFABRICADOS FORTE, S.L.  
22.270 Ctra. Artasona s/n, Almudévar (Huesca)

REV: <b>A</b>	REALIZADO POR:	P.G.P.	FECHA:	29/04/2020
	VERIFICADO POR:	P.G.P.	REEMPLAZA:	----