

PESO POR MARCO: 13.61 t

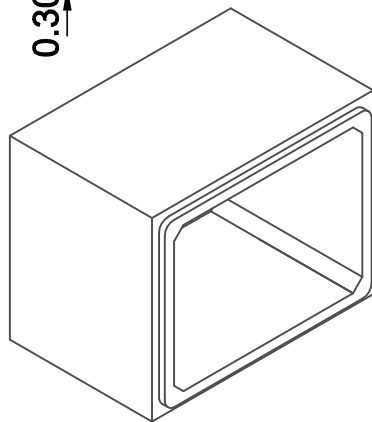

NORMA: EN 14844:2007 + A2 - Febrero 2012



MARCO 3.00x2.50x1.50 (30/25)



PREFABRICADOS FORTE, S.L.
22.270 Ctra. Artasona s/n, Almudévar (Huesca)

REV: A	REALIZADO POR:	P.G.P.	FECHA:	30/04/2020
	VERIFICADO POR:	P.G.P.	REEMPLAZA:	----