

PESO POR MARCO: 13.20 t

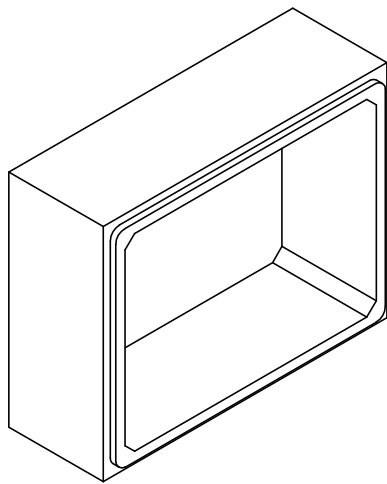

NORMA: EN 14844:2007 + A2 - Febrero 2012



MARCO 4.00x3.00x1.25 (30/25)



PREFABRICADOS FORTE, S.L.
22.270 Ctra. Artasona s/n, Almudévar (Huesca)

REV: A	REALIZADO POR:	P.G.P.	FECHA:	31/07/2018
	VERIFICADO POR:	P.G.P.	REEMPLAZA:	----